

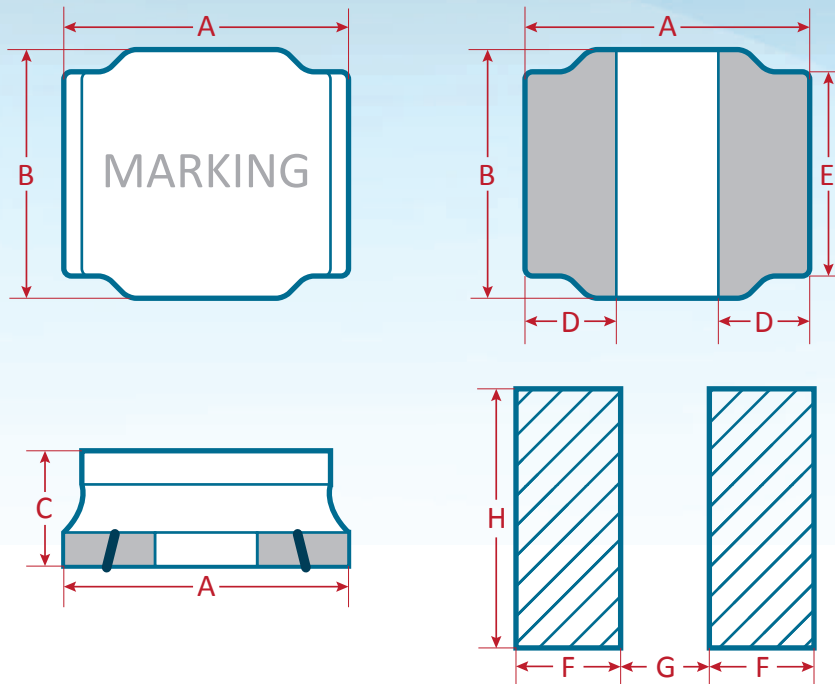

# HNT Series

## SMD Power Inductor

Shape and Dimensions(mm):



Item	A	B	C	D	E	F	G	H
HNT8040	8.0±0.2	8.0±0.2	4.0 <sup>+0.2</sup> <sub>-0.3</sub>	2.45 Typ	6.3 Typ.	2.75 Typ.	2.8 Typ.	6.6 Typ.

### HNT8040

Part No.	Inductance (uH)	DCR(mΩ) ±30%	Isat(A)		Irms(A)		Tolerance (±%)
			Typ.	Max.	Typ.	Max.	
HNT8040NTR90	0.9	7.0	13.8	12.42	8.05	7.24	30
HNT8040NT1R0	1.0	7.5	13	11.7	7.95	7.15	30
HNT8040NT1R4	1.4	9.0	10.8	9.72	7.8	7.02	30
HNT8040NT1R5	1.5	9.5	10	9.0	7.7	6.93	30
HNT8040MT2R0	2.0	11	9.6	8.64	7.4	6.66	20
HNT8040MT2R2	2.2	11.5	9.2	8.28	7.2	6.48	20
HNT8040MT2R5	2.5	13	8.2	7.38	6.3	5.67	20
HNT8040MT3R3	3.3	15	7.5	6.75	6.0	5.4	20
HNT8040MT3R9	3.9	18	6.1	5.4	5.5	4.9	20
HNT8040MT4R7	4.7	18	6.0	5.4	5.5	4.95	20
HNT8040MT5R6	5.6	23	5.7	5.13	5.2	4.68	20
HNT8040MT6R8	6.8	25	5.4	4.86	5.1	4.59	20
HNT8040MT100	10	38	4.3	3.87	3.8	3.42	20
HNT8040MT120	12	45	3.8	3.42	3.5	3.15	20
HNT8040MT150	15	50	3.6	3.24	3.2	2.88	20
HNT8040MT180	18	68	3.1	2.79	2.7	2.43	20
HNT8040MT220	22	80	2.8	2.52	2.6	2.34	20
HNT8040MT330	33	110	2.3	2.07	2.0	1.8	20
HNT8040MT470	47	160	1.9	1.71	1.75	1.57	20
HNT8040MT680	68	240	1.7	1.53	1.45	1.3	20
HNT8040MT101	100	340	1.4	1.26	1.1	0.99	20

Part No.	Inductance (uH)	DCR(mΩ) ±30%	Isat(A)		Irms(A)		Tolerance (±%)
			Typ.	Max.	Typ.	Max.	
HNT8040MT121	120	425	1.1	0.99	1.0	0.9	20
HNT8040MT151	150	480	1.0	0.9	0.9	0.81	20
HNT8040MT181	180	650	0.98	0.88	0.7	0.63	20
HNT8040MT221	220	670	0.94	0.84	0.6	0.54	20
HNT8040MT271	270	900	0.83	0.74	0.55	0.49	20
HNT8040MT821	820	2800	0.4	0.36	0.38	0.34	20

HNT8040NTR90

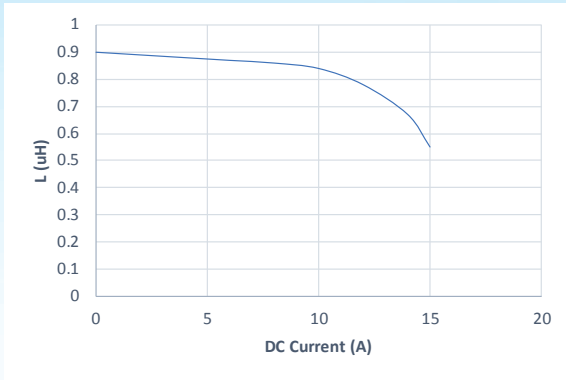

HNT8040NT1R0

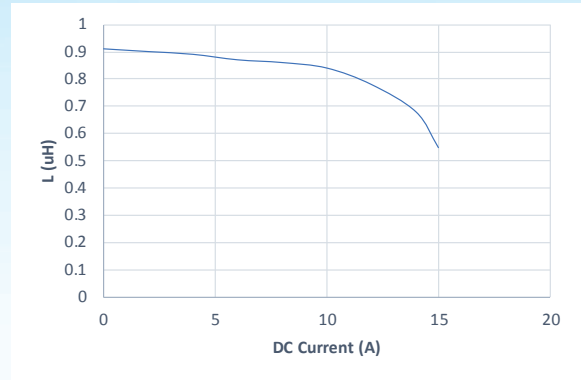

HNT8040NT1R4

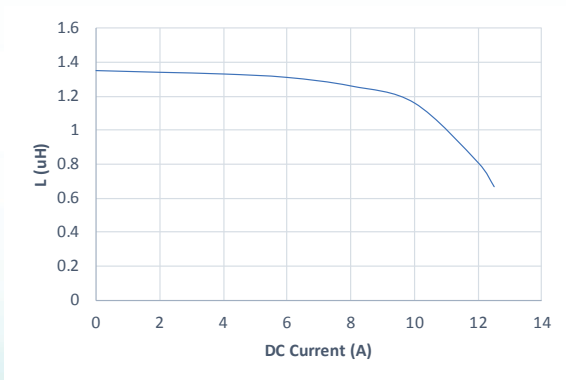

HNT8040NT1R5

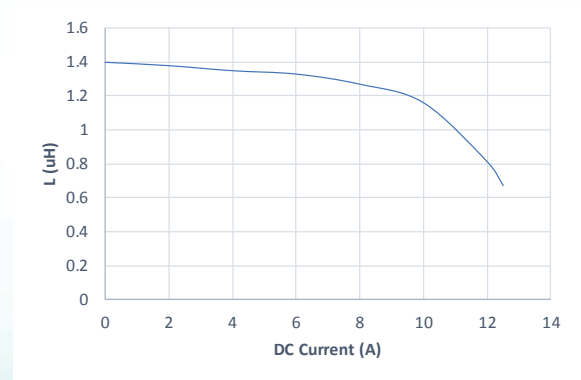

HNT8040MT2R0

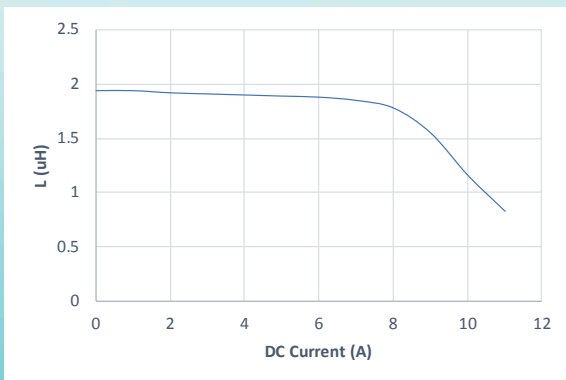

HNT8040MT2R2

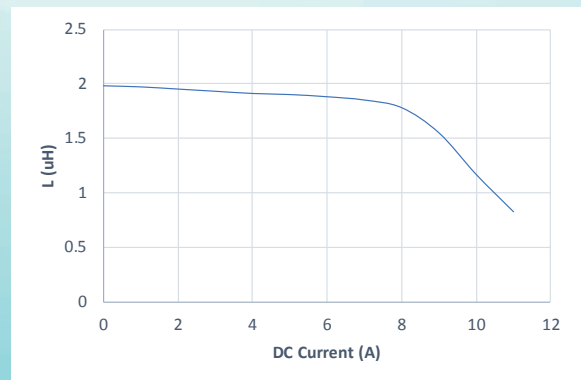

HNT8040MT2R5

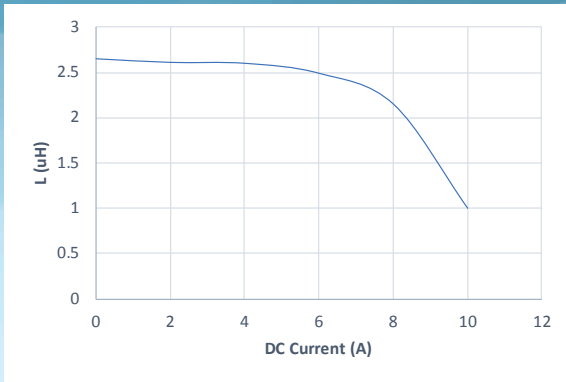

HNT8040MT3R3

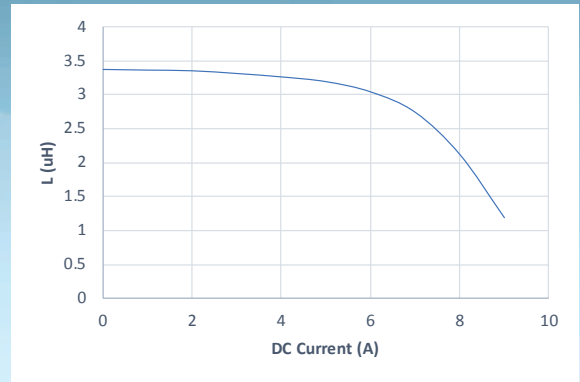

HNT8040MT3R9

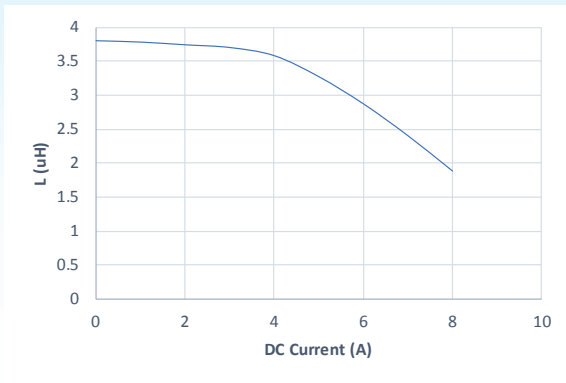

HNT8040MT4R7

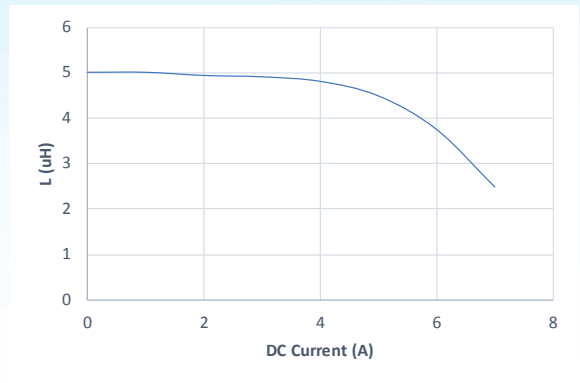

HNT8040MT5R6

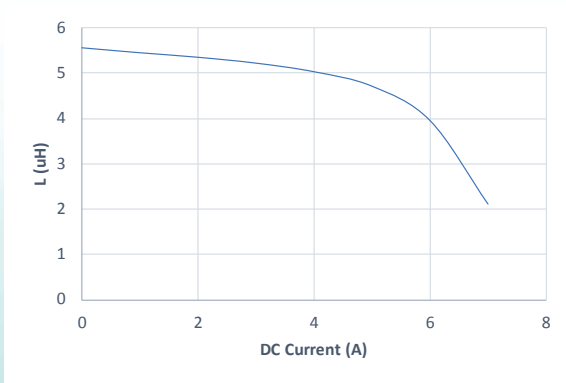

HNT8040MT6R8

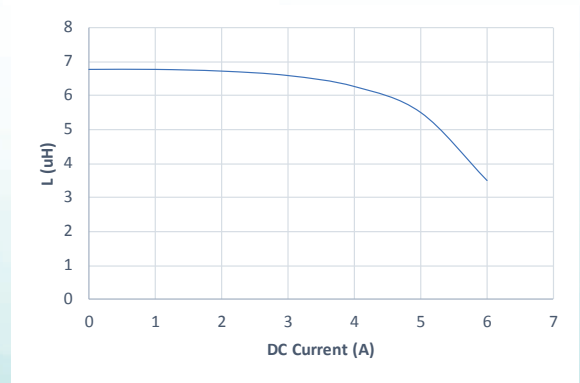

HNT8040MT100

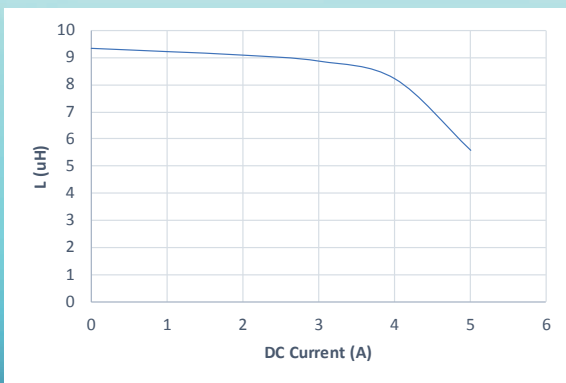

HNT8040MT120

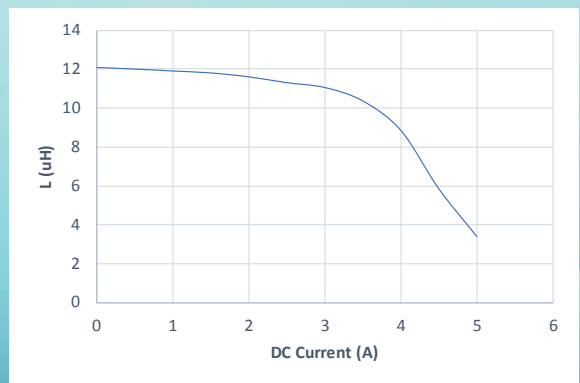

HNT8040MT150

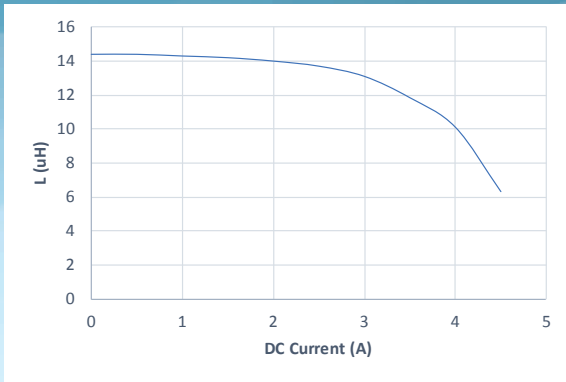

HNT8040MT180

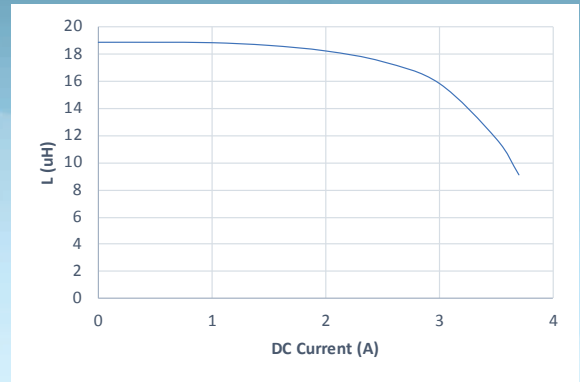

HNT8040MT220

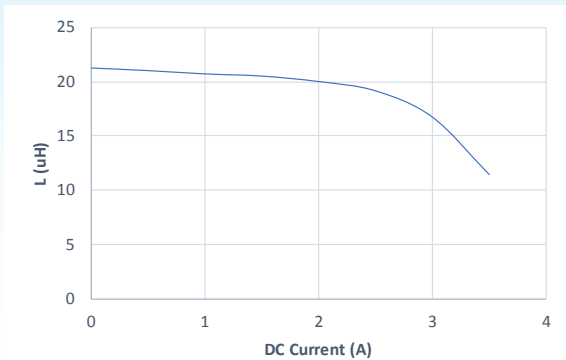

HNT8040MT330

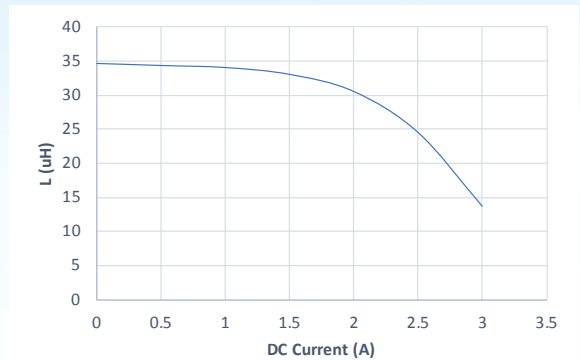

HNT8040MT470

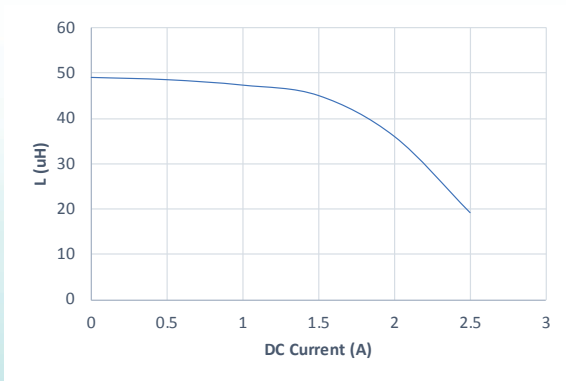

HNT8040MT680

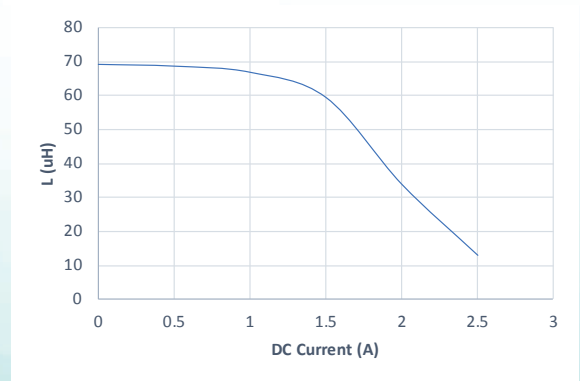

HNT8040MT101

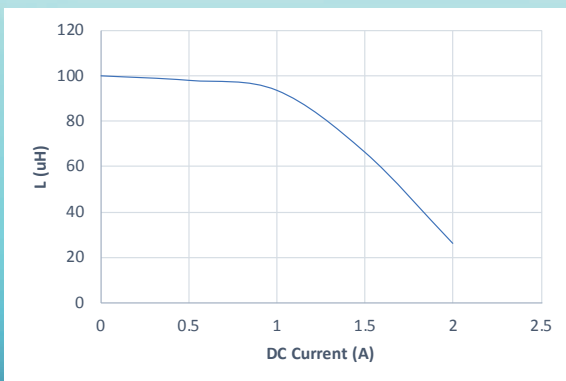

HNT8040MT121

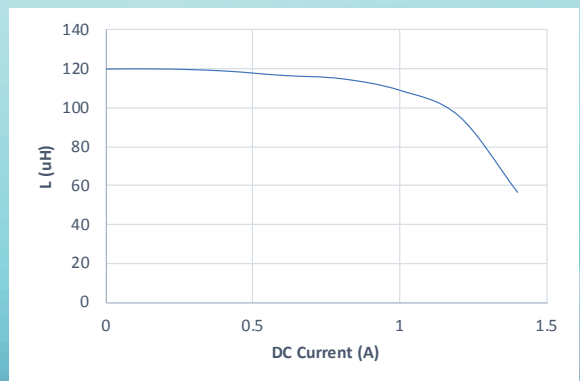

HNT8040MT151

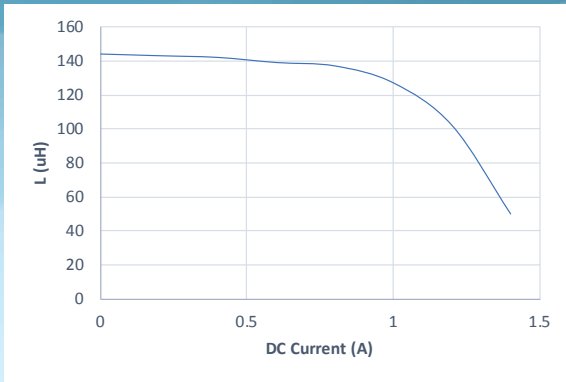

HNT8040MT181

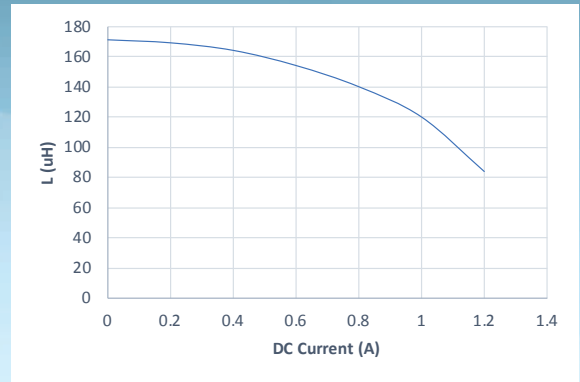

HNT8040MT221

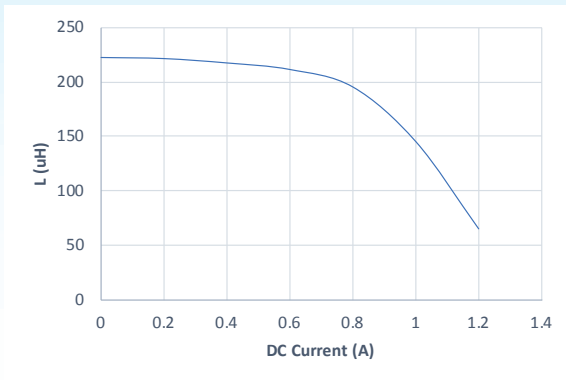

HNT8040MT271

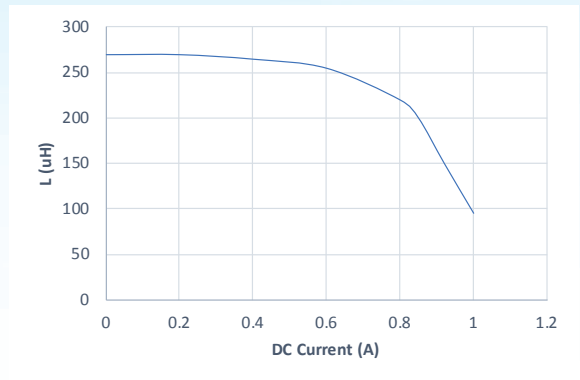

HNT8040MT821

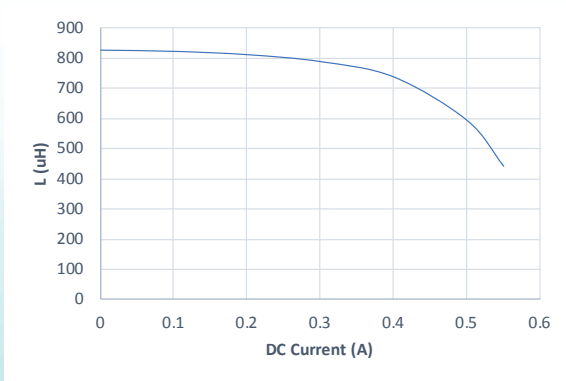

## Ordering information

### HNT - 8040 - M - T - 1R0

(1) (2) (3) (4) (5)

- ( 1 ) Type : SMD Power Inductor
- ( 2 ) Size : 8040 is size
- ( 3 ) Tolerance : M=20%
- ( 4 ) Packaging style : Taping Reel
- ( 5 ) Inductance : R90 for 0.9 uH, 1R0 for 1.0uH, 100 for 10uH, 101 for 100uH...

## Characteristics

- Isat for Inductance drop 30% from its value without current
- Irms for a 40°C rise above 25°C ambient
- Operating temperature range : -40°C to 125°C (Including self-temperature rise)

## Test equipment

- L : CH1062, 100kHz, 1V
- DCR:502BC
- Isat:CH1062+CH1310 100kHz, 1V

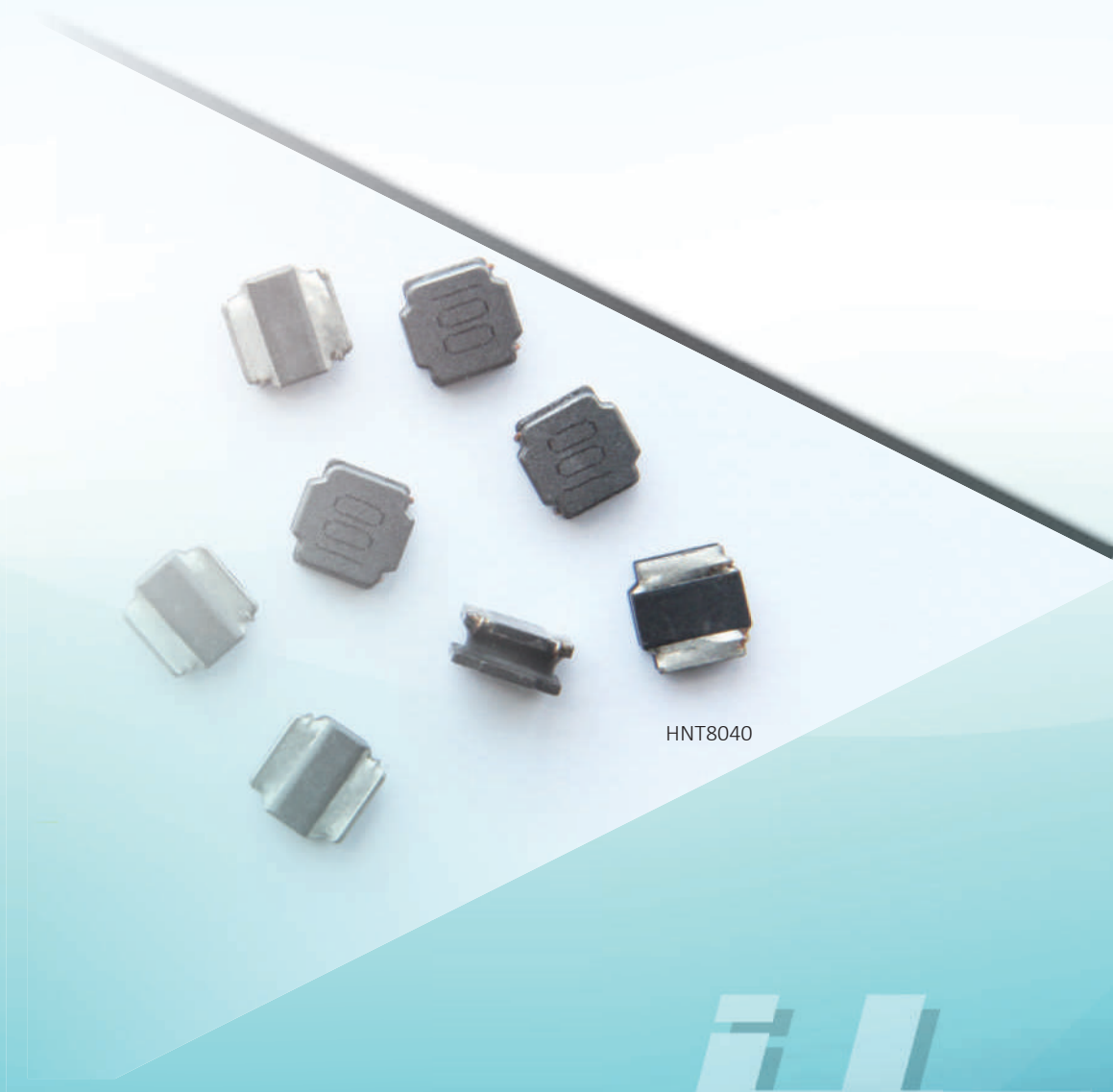

HNT8040

# Packing

Dimensions in mm

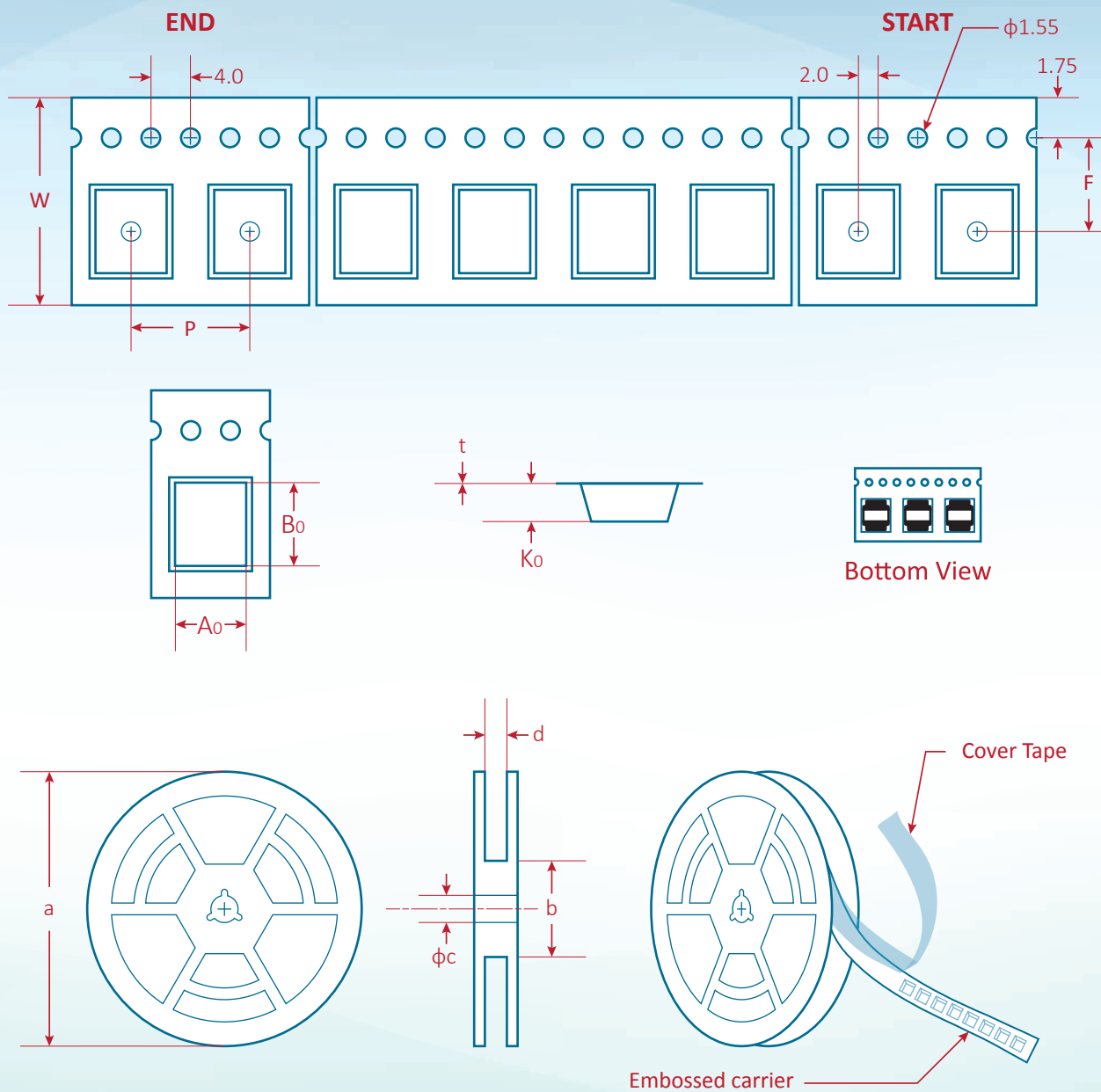

Item	F	W	P	A <sub>0</sub>	B <sub>0</sub>	K <sub>0</sub>	a	b	φ <sub>c</sub>	d
HNT8040	7.5	16	12	8.25	8.25	4.15	330	100	13	16
Reel										
Q'ty(Pcs)										
1,000										