

Shape and Dimensions(mm):

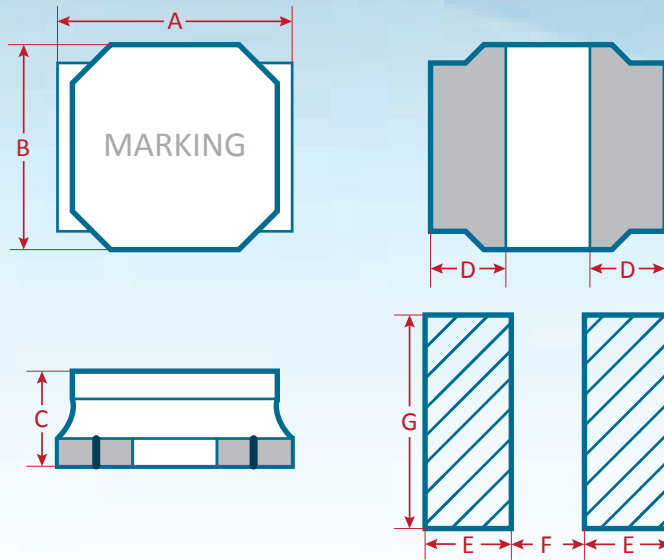

Item	A	B	C	D	E	F	G
HNT6020	6.0±0.2	6.0±0.2	2.0 ^{+0.2} _{-0.3}	1.65 Typ.	1.6 Typ.	2.9 Typ.	5.7 Typ.

HNT6020



Part No.	Inductance (uH)	DCR(mΩ) ±30%	Isat(A)		Irms(A)		Tolerance (±%)
			Typ.	Max.	Typ.	Max.	
HNT6020NTR50	0.5	13	8.0	7.2	5.3	4.77	30
HNT6020NTR90	0.9	18	6.3	5.67	4.2	3.78	30
HNT6020MT1R0	1.0	19	6.2	5.58	4.1	3.69	20
HNT6020MT1R5	1.5	26	5.0	4.5	3.6	3.24	20
HNT6020MT2R2	2.2	34	4.2	3.78	3.2	2.88	20
HNT6020MT3R3	3.3	40	3.2	2.88	2.7	2.43	20
HNT6020MT4R7	4.7	58	2.5	2.25	2.2	1.98	20
HNT6020MT6R8	6.8	85	2.2	1.98	1.8	1.62	20
HNT6020MT100	10	125	2.0	1.8	1.6	1.44	20
HNT6020MT150	15	190	1.3	1.17	1.3	1.17	20
HNT6020MT220	22	260	1.1	0.99	1.1	0.99	20

HNT6020NTR50

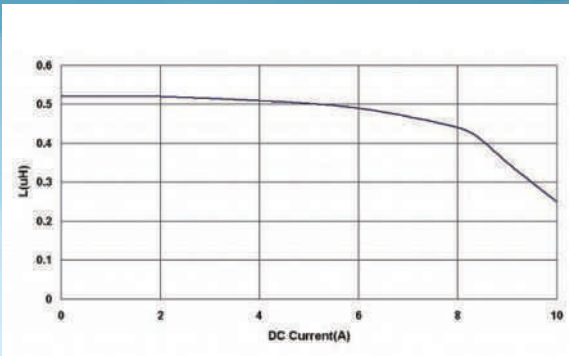

HNT6020NTR90

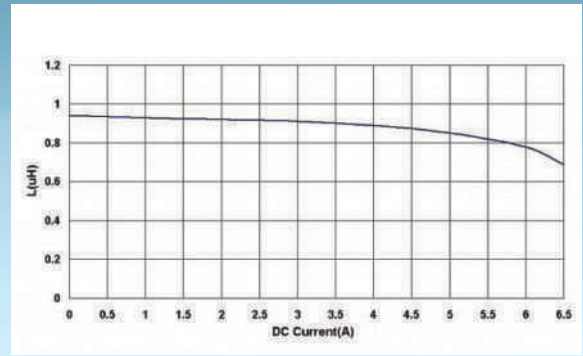

HNT6020MT1R0

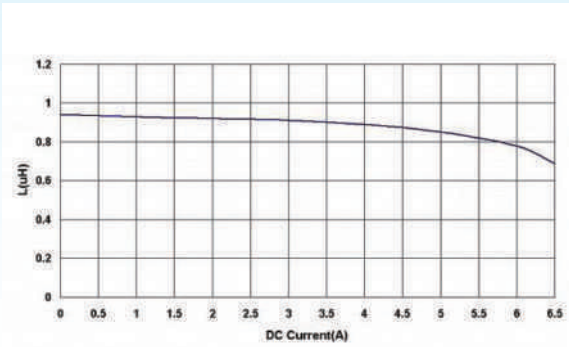

HNT6020MT1R5

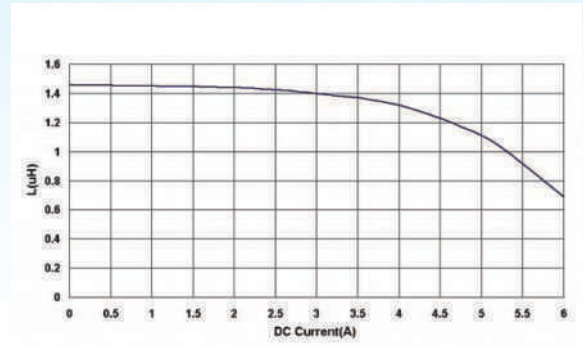

HNT6020MT2R2

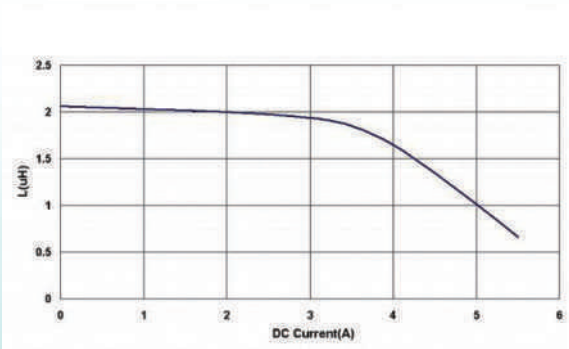

HNT6020MT3R3

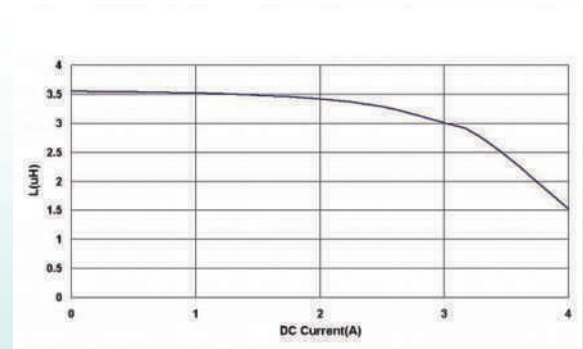

HNT6020MT4R7

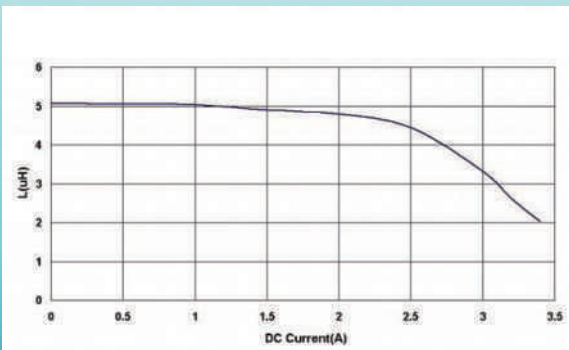

HNT6020MT6R8

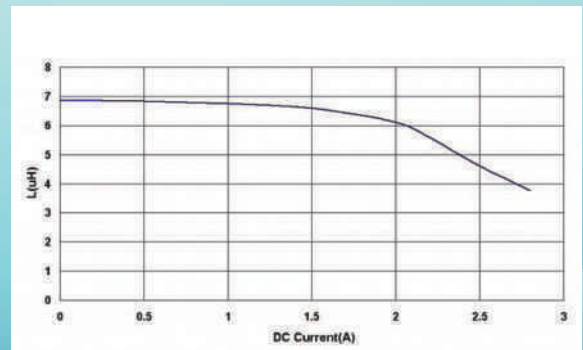

HNT6020MT100

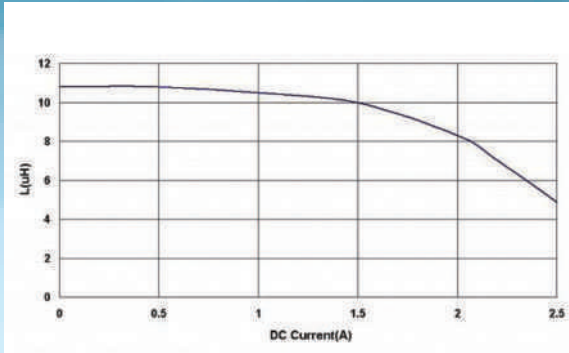

HNT6020MT150

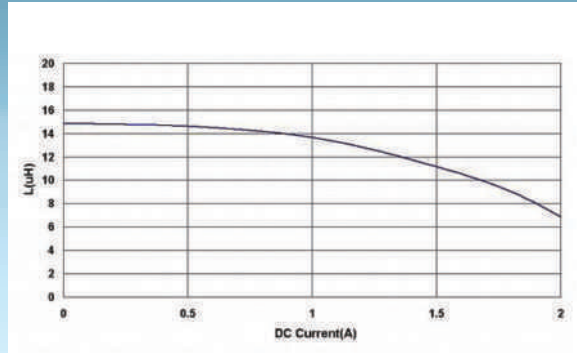

HNT6020MT220

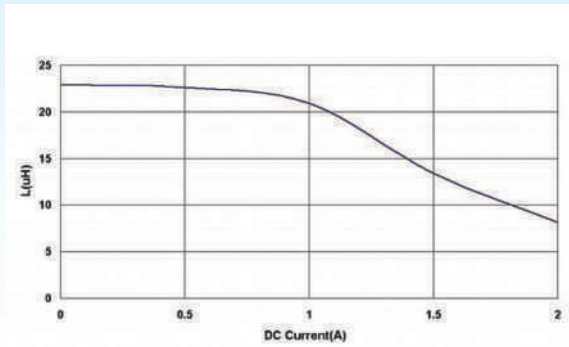

Ordering information

HNT - 6020 - M - T - 1R0

(1) (2) (3) (4) (5)

- (1) Type : Surface Mountable Type
- (2) Size : 6020 is size
- (3) Tolerance : N=30%,M=20%
- (4) Packaging style : Taping Reel
- (5) Inductance : R50 for 0.5uH, 1R0 for 1.0uH, 100 for 10uH...

Characteristics

- Isat : Based on Inductance decrease 30%
- Irms : Based on Temperature increase 40°C
- Operating temperature range : -40 to +125°C (Including self-temperature rise)
- Storage Temp : 0°C to +40°C (RH 70% Max)

Test equipment

- Test Frequency : 100KHz/ 1.0V
- L : GKT-3250
- Isat&Irms : CH2816+WR7210
- DCR: GKT-502BC



Packing

Dimensions in mm

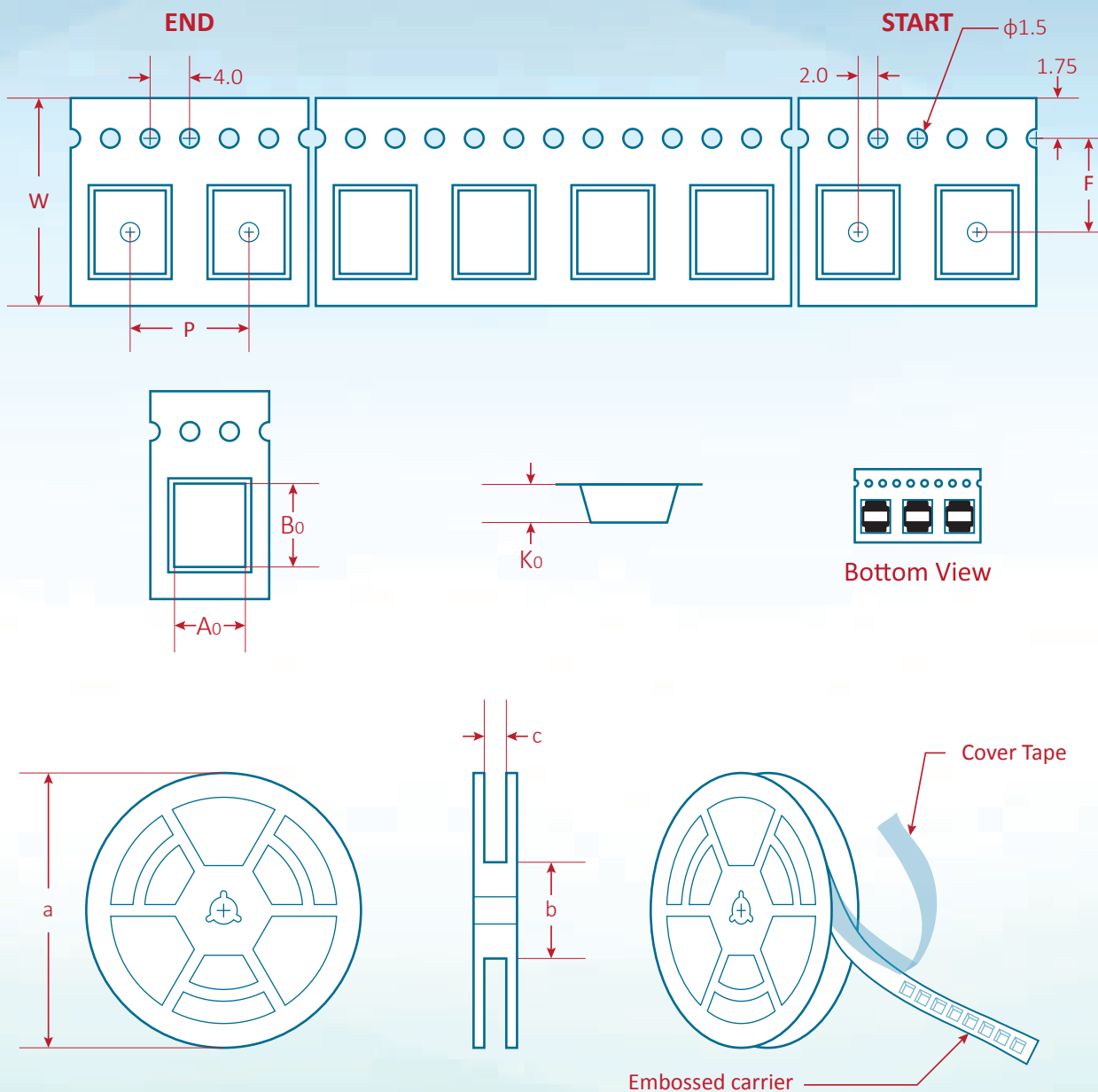

Item	F	W	P	A ₀	B ₀	K ₀	a	b	c
HNT6020	7.5	16	12	6.3	6.3	2.3	330	100	16.5
Reel									
Q'ty(Pcs)									
2,000									