

Shape and Dimensions(mm):

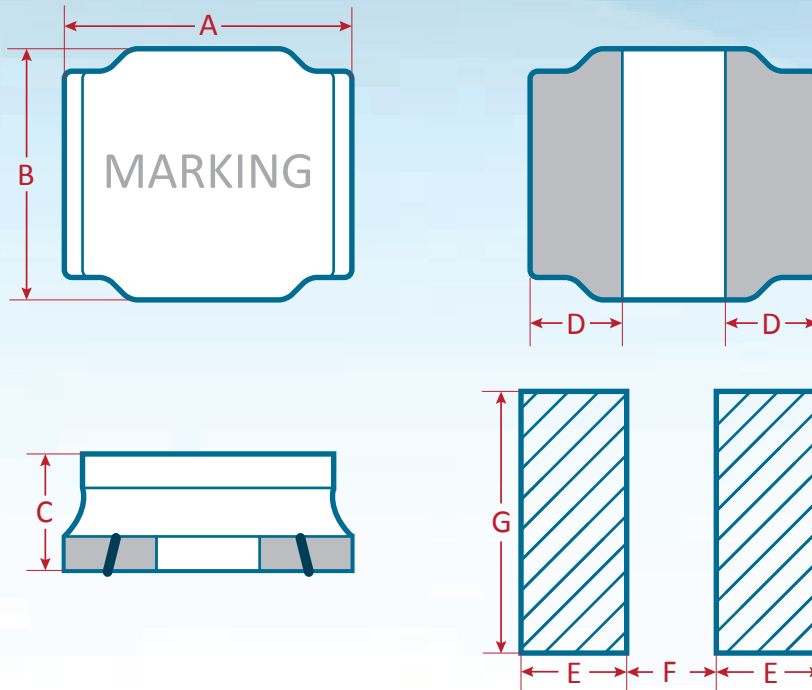

Item	A	B	C	D	E	F	G
HNT5020	5.0±0.2	5.0±0.2	2.0 ^{+0.2} _{-0.3}	1.35 Typ.	1.5 Typ.	2.1 Typ.	4.0 Typ.

HNT5020

Part No.	Inductance (uH)	DCR(mΩ) ±20%	Isat(A)		Irms(A)		Tolerance (±%)
			Typ.	Max.	Typ.	Max.	
HNT5020MT1R0	1.0	21	5.1	4.59	4.0	3.6	20
HNT5020MT1R2	1.2	21	4.8	4.32	3.8	3.42	20
HNT5020MT1R5	1.5	26	4.2	3.78	3.5	3.15	20
HNT5020MT2R2	2.2	35	3.4	3.06	3.2	2.88	20
HNT5020MT3R3	3.3	48	3.0	2.7	2.8	2.52	20
HNT5020MT4R7	4.7	60	2.2	1.98	2.2	1.98	20
HNT5020MT5R6	5.6	82	2.05	1.84	2.0	1.8	20
HNT5020MT6R8	6.8	90	2.0	1.8	1.8	1.62	20
HNT5020MT100	10	120	1.6	1.44	1.6	1.44	20
HNT5020MT150	15	190	1.3	1.17	1.2	1.08	20
HNT5020MT220	22	260	1.0	0.9	1.0	0.9	20
HNT5020MT330	33	460	0.8	0.72	0.75	0.67	20
HNT5020MT470	47	580	0.65	0.58	0.65	0.6	20

HNT5020MT1R0

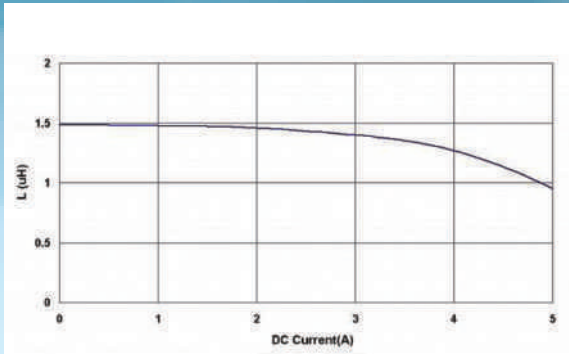

HNT5020MT1R2

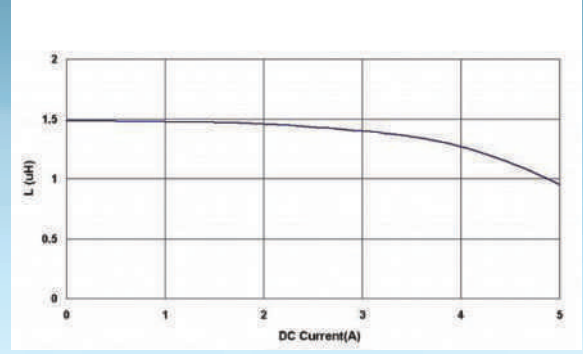

HNT5020MT1R5

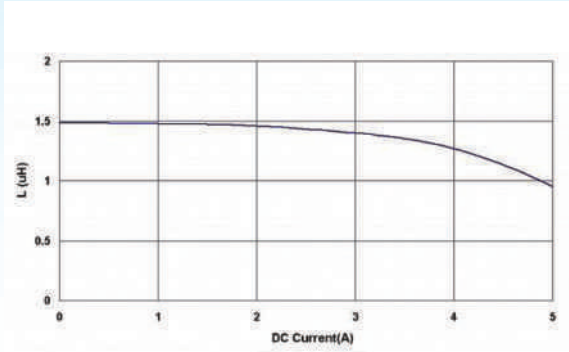

HNT5020MT2R2

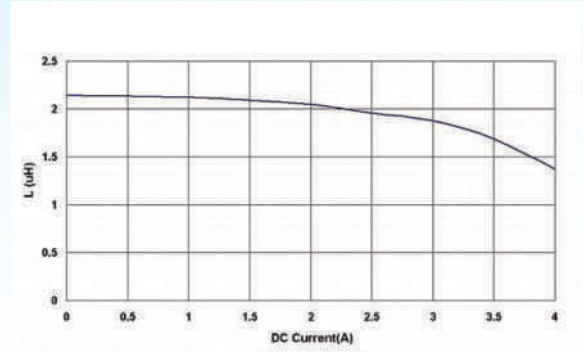

HNT5020MT3R3

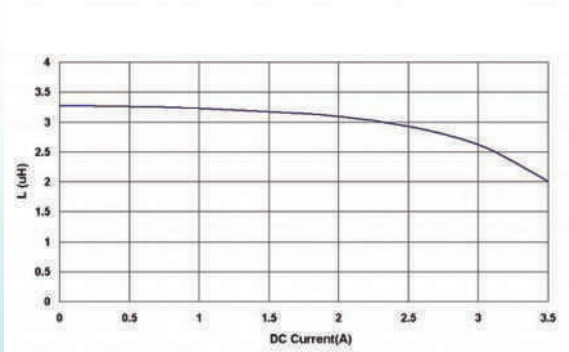

HNT5020MT4R7

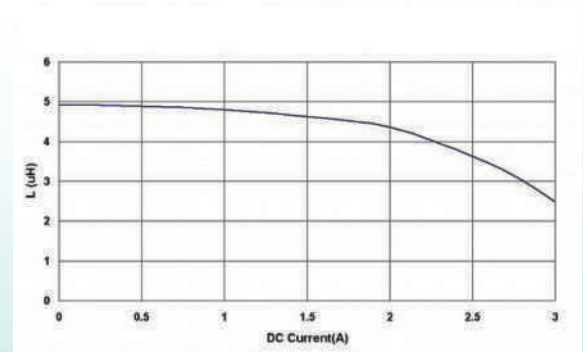

HNT5020MT5R6

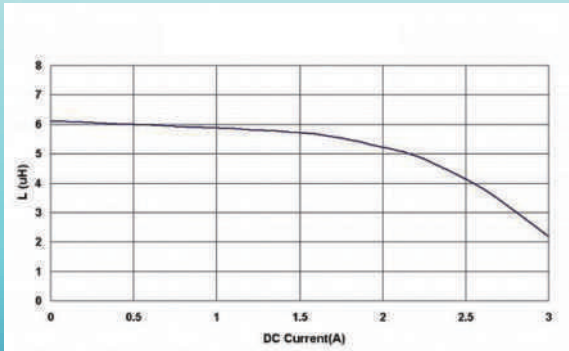

HNT5020MT6R8

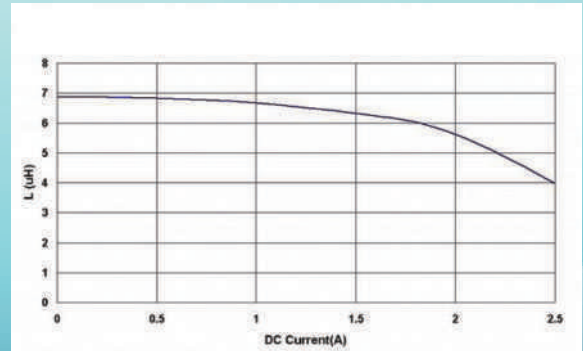

HNT5020MT100

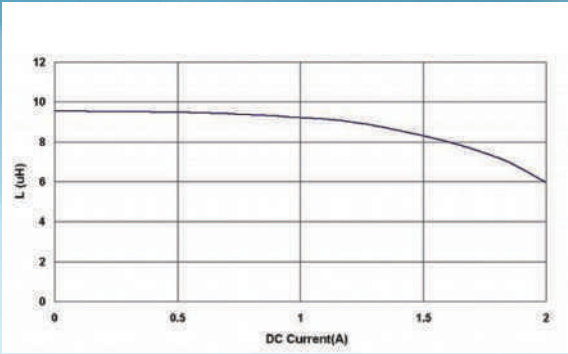

HNT5020MT150

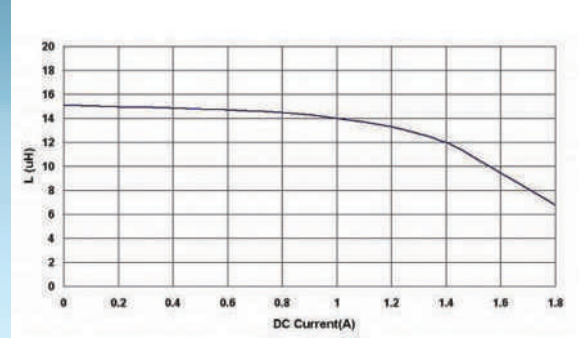

HNT5020MT220

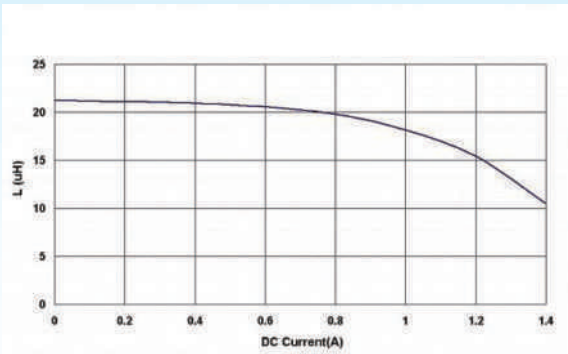

HNT5020MT330

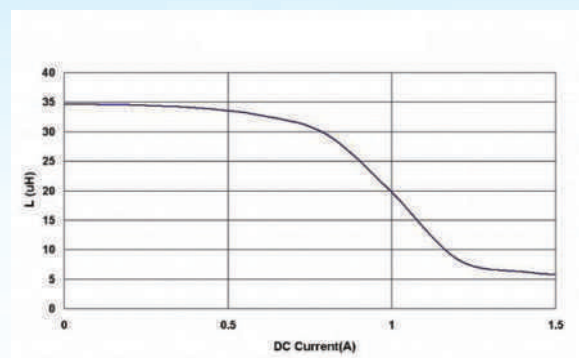

HNT5020MT470

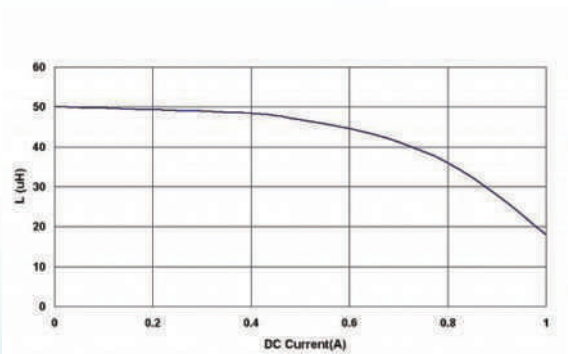

Ordering information

HNT - 5020 - M - T - 1R0

(1) (2) (3) (4) (5)

- (1) Type : Surface Mountable Type
- (2) Size : 5020 is size
- (3) Tolerance : M=20%
- (4) Packaging style : Taping Reel
- (5) Inductance : 1R0 for 1.0uH, 100 for 10uH...

Characteristics

- Isat : Based on Inductance decrease 30%
- Irms : Based on Temperature increase 40°C
- Operating temperature range : -40 to +125°C (Including self-temperature rise)
- Storage Temp : 0°C to +40°C (RH 70% Max)

Test equipment

- Test Frequency : 100KHz/ 1.0V
- L : GKT-3250
- Isat&Irms : CH2816+WR7210
- DCR: GKT-502BC

Packing

Dimensions in mm

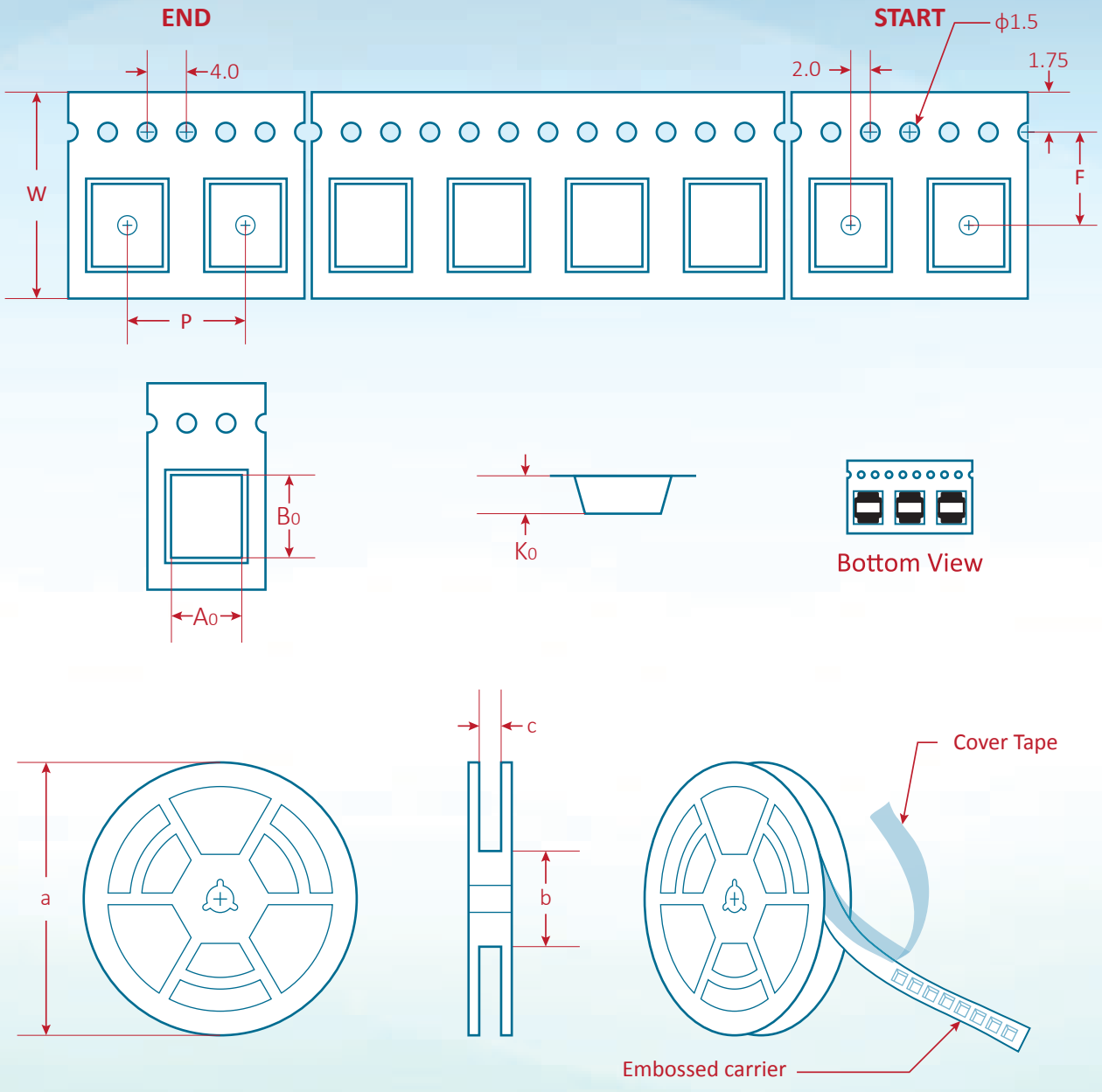

Item	F	W	P	Ao	Bo	Ko	a	b	c
HNT5020	5.5	12	8.0	5.3	5.3	2.3	330	100	12.5
Reel									
Q'ty(Pcs)									
2,000									