

SPECIFICATION FOR APPROVED 樣品承認書

2024
NEW

機構圖 Shape and Dimensions(mm) :

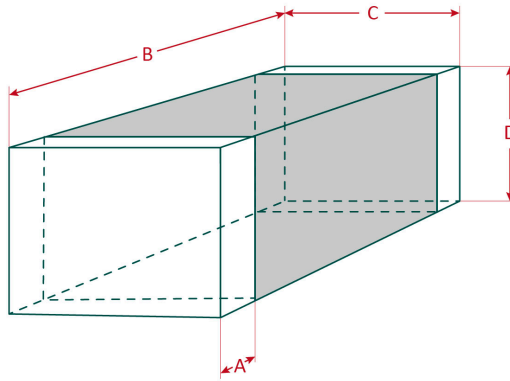

Item	A	B	C	D
WBH03-M	0.2~0.6	1.6±0.15	0.8±0.15	0.8±0.15

印字Marking : N/A

WBH03-M

Part No.	Impedance (Ω)	Test Frequency	Test Voltage	DC Resistance	Rated Current
	Tolerance	(MHz)	(mV)	(Ω) Max.	(mA) Max.
WBH03YT190-M	19±25%	100	500	0.04	3000
WBH03YT220-M	22±25%	100	500	0.04	3000
WBH03YT300-M	30±25%	100	500	0.04	3000
WBH03YT310-M	31±25%	100	500	0.04	3000
WBH03YT330-M	33±25%	100	500	0.04	3000
WBH03YT500-M	50±25%	100	500	0.04	3000
WBH03YT600-M	60±25%	100	500	0.04	3000
WBH03YT700-M	70±25%	100	500	0.04	3000
WBH03YT800-M	80±25%	100	500	0.04	3000
WBH03YT101-M	100±25%	100	500	0.04	3000
WBH03YT121-M	120±25%	100	500	0.04	3000
WBH03YT151-M	150±25%	100	500	0.05	2000

SPECIFICATION FOR APPROVED 樣品承認書

2024
NEW

Part No.	Impedance (Ω)	Test Frequency	Test Voltage	DC Resistance	Rated Current
	Tolerance	(MHz)	(mV)	(Ω) Max.	(mA) Max.
WBH03YT181-M	180 \pm 25%	100	500	0.08	2000
WBH03YT221-M	220 \pm 25%	100	500	0.08	2000
WBH03YT301-M	300 \pm 25%	100	500	0.10	2000
WBH03YT601-M	600 \pm 25%	100	500	0.20	1000
WBH03YT102-M	1000 \pm 25%	100	500	0.20	1000

Ordering information

WBH - 03 - Y - T - 190 - M

(1) (2) (3) (4) (5) (6)

- (1) Type : Power Inductor
- (2) Size : 03 is size
- (3) Tolerance : Y \pm 25%
- (4) Packaging style : Taping Reel
- (5) Inductance : 190 for 19 Ω , 101 for 100 Ω , 102 for 1000 Ω ...
- (6) Item number : M

Characteristics

- STANDARD ATMOSPHERIC CONDITIONS
- Unless otherwise specified the standard range of atmospheric conditions for making measurements and tests is as follows:
 - Ambient temperature : 20 \pm 15 $^{\circ}$ C
 - Relative humidity : 30~70%
- If there may be any doubt on the results, measurements shall be made within the following limits :
 - Ambient temperature : 25 \pm 5 $^{\circ}$ C
 - Relative humidity : 30~70%
 - Operating temperature: -55~+125 $^{\circ}$ C

Test equipment

- HP-4286A
- HP-4338 digital mili-ohm meter

性能曲線 PERFORMANCE CURVES :

WBH03YT190-M

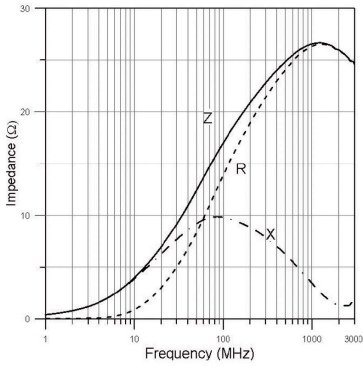

WBH03YT220-M

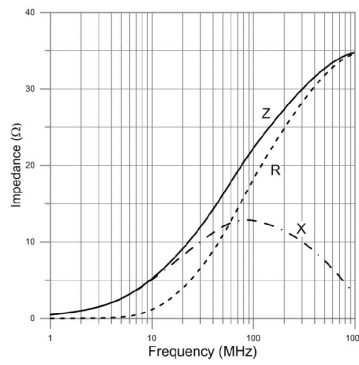

WBH03YT300-M

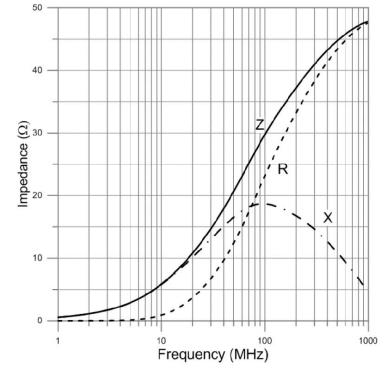

WBH03YT310-M

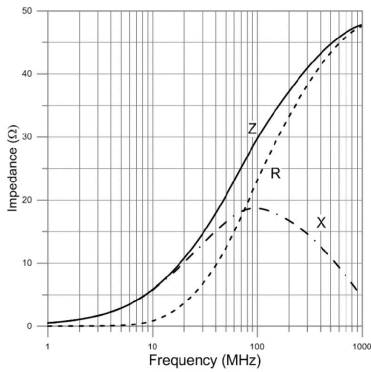

WBH03YT330-M

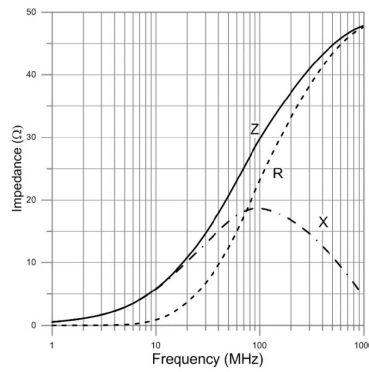

WBH03YT500-M

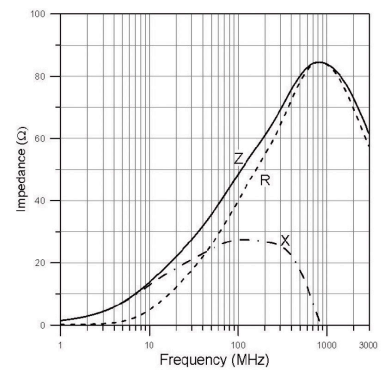

WBH03YT600-M

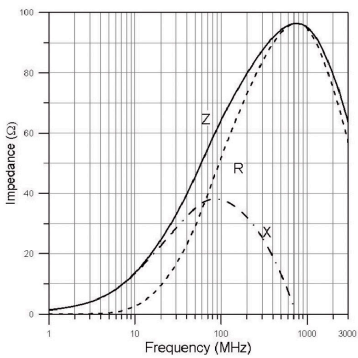

WBH03YT700-M

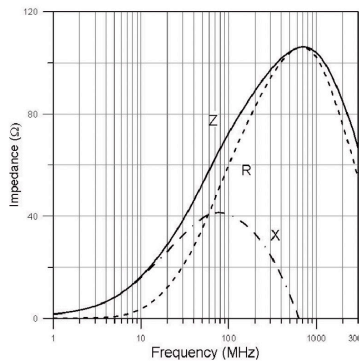

WBH03YT800-M

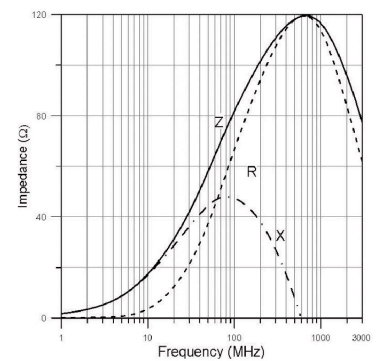

性能曲線 PERFORMANCE CURVES :

WBH03YT101-M

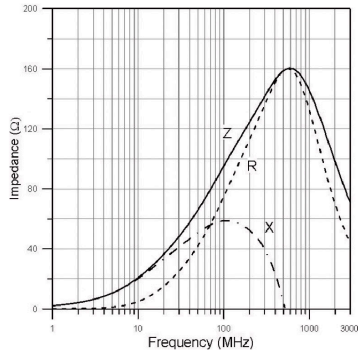

WBH03YT121-M

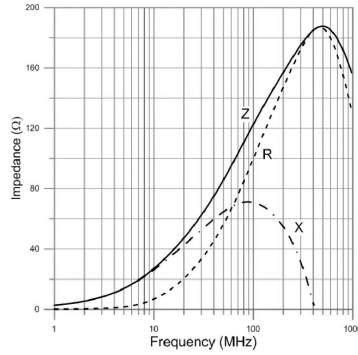

WBH03YT151-M

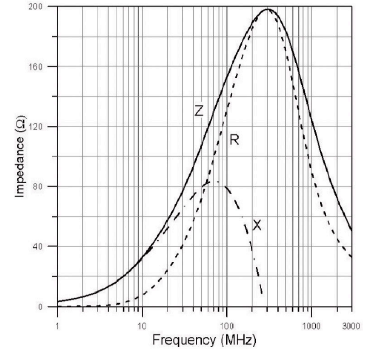

WBH03YT181-M

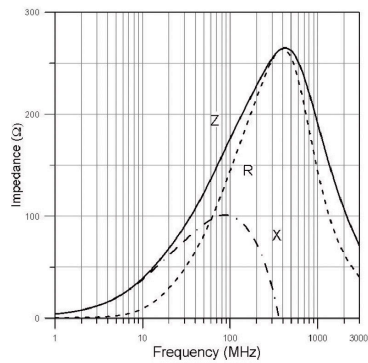

WBH03YT301-M

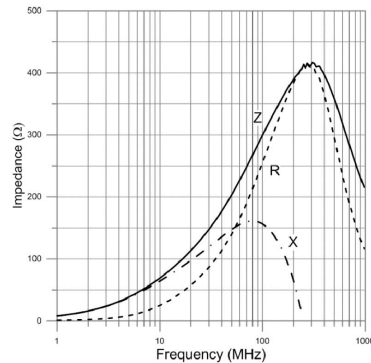

WBH03YT601-M

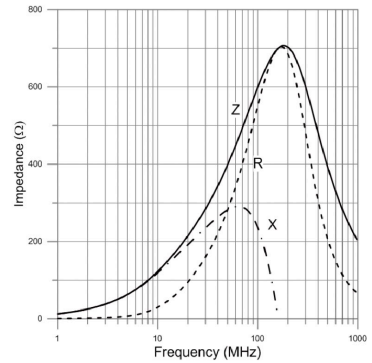

WBH03YT102-M

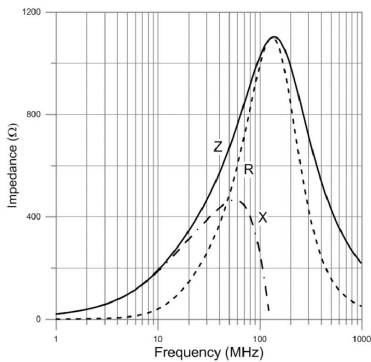

TAPE AND REEL SPECIFICATIONS

Dimensions in mm

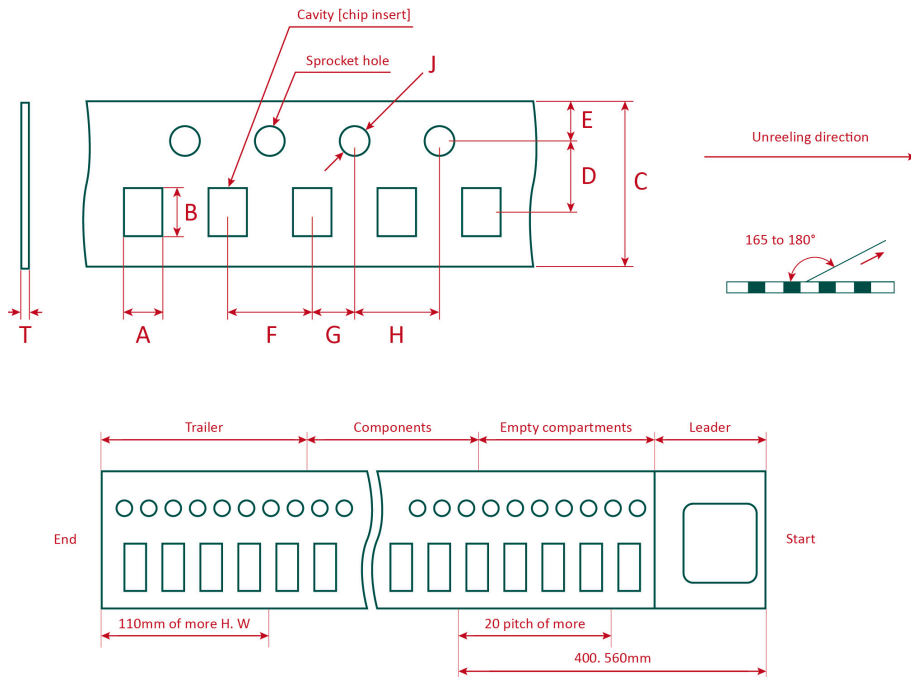

Type	A	B	C	D	E	F	G	H	J	T
WBH03-M	1.03 ±0.05	1.85 ±0.05	8.00 ±0.10	3.50 ±0.05	1.75 ±0.10	4.00 ±0.10	2.00 ±0.05	4.00 ±0.10	1.55 ±0.05	0.95 ±0.05

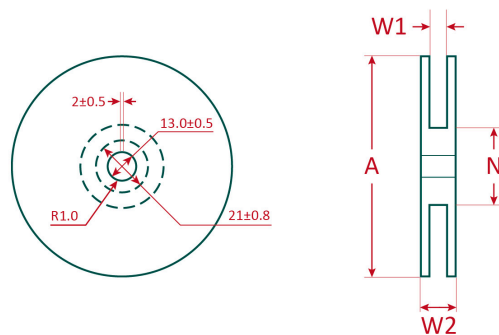

Type	A	N	W1	W2
WBH03-M	178±2.0	50 Min.	10±1.5	20 Max.

Packing Quantity

4000 Pcs / Reel